

## RRD Silencioso

---

*August 2014*

*Version 1*

*User Guide Created by @mundsen*

# Reprapdiscount

## USER GUIDE

*Copyright and third-party information as required*

### Table of Contents

1	Introduction .....	4
1.1	<i>RRD Silencioso (THB6128) Driver</i> .....	4
1.2	<i>Unboxing</i> .....	5
2	Installing.....	7
2.1	<i>Stepper motor</i> .....	7
2.2	<i>Wiring diagram</i> .....	9
2.2.1	<i>Silencioso</i> .....	9
2.2.2	<i>Rumba + Silencioso</i> .....	10
2.2.3	<i>Ramps 1.4 + Silencioso</i> .....	11
2.2.4	<i>Silencioso used in combination with dual motor setup (2 x Z motors). Alternative 1</i> .....	12
2.2.5	<i>Silencioso used in combination with dual motor setup (2 x Z motors). Alternative 2</i> .....	13
2.3	<i>Mounting and Wiring the Silencioso driver on the stepper motor</i> .....	14
2.4	<i>Mount the stepper adapter on your controller and connect the cables</i> .....	18
2.4.1	<i>Rumba</i> .....	18
2.4.2	<i>Ramps 1.4</i> .....	19
2.5	<i>Set step mode</i> .....	20
2.6	<i>Adjusting stepper current (CUR)</i> .....	20
2.7	<i>Activating and adjusting Hold Current (HC)</i> .....	20
2.8	<i>Adjusting Decay</i> .....	20
2.9	<i>Connecting a fan</i> .....	20
2.10	<i>Modify settings in Marlin</i> .....	21
2.10.1	<i>Stepper Enable Pins</i> .....	21
2.10.2	<i>Stepper rotation direction</i> .....	22
2.10.3	<i>Steps/mm (micro stepping)</i> .....	23
3	Appendice/Notes .....	24

## 1 Introduction

### 1.1 RRD Silencioso (THB6128) Driver

- For mounting directly on the NEMA17 stepper motor
- Uses it`s own separate power supply from 12V to 24V directly at the stepper motor. The total current required from your PSU depends on your machine setup.
- All inputs are protected with opto-isolators
- Supports both 3,3V and 5V logic
- From 1 (full step) to 128 micro steps (max recommended for 8 Bit Electronics: 32 micro steps)
- Max current 2,1A

#### **WARNING:**

- Always make sure the polarity is correct when wiring in power inputs. Reversed polarity can damage or destroy the board.
- Never disconnect or connect the stepper motors when the power is on.

### 1.2 Unboxing

The Silencioso arrives in a practical plastic box



Box content:

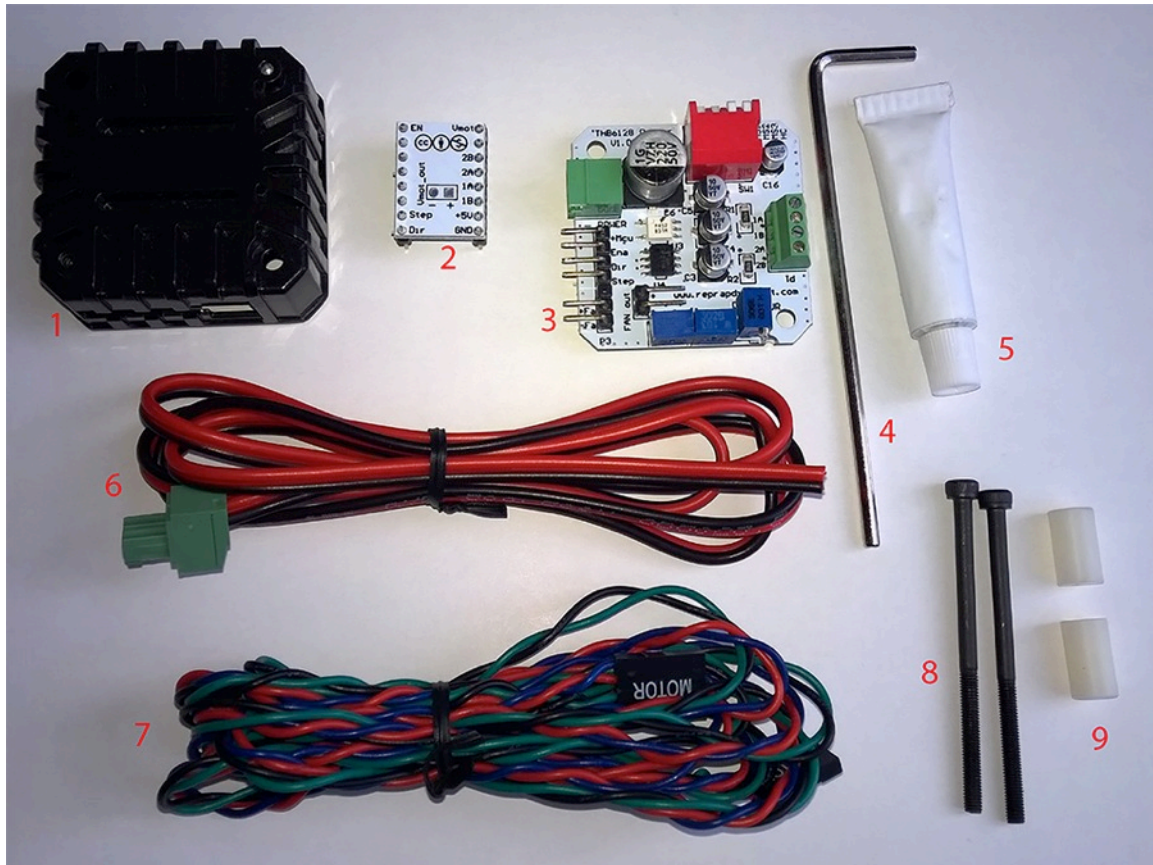

1. *Housing/cooler*
2. *Stepper driver adapter*
3. *Silencioso driver board*
4. *Allen wrench*
5. *Thermal paste*
6. *Power cable (from Silencioso to power supply)*
7. *Motor cable (used from Silencioso to controller board)*
8. *2x 50mm M3 screws (you may have to use other screw lengths depending on your servo type)*
9. *2x plastic spacers*

## 2 Installing

### 2.1 Stepper motor

Before you can connect the stepper motor to the Silencioso you need some information on the stepper motor you have.

Look at your motor, find it's part number. Then Google it. Try to find a schematic or a data-sheet that will indicate which wire goes to which pole. Note the colors that correspond to each coil.

#### Wiring diagram (接线图):

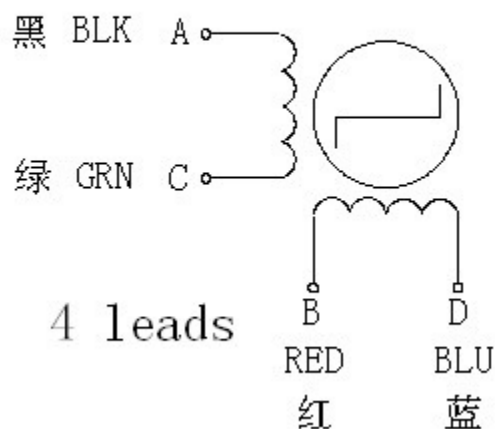

Wiring diagram for Wantai 42BYGHW609 stepper motor (from [www.wantamotor.com](http://www.wantamotor.com)).

If you can't find the motor's part number, you can use another method to find the motor's pole pairs.

When two wires for a pole (A + C or B + D) touch together it makes a closed circuit for that pole and it gets harder to turn the stepper motor.

1. Try to turn the motor when no cables touch together – it should turn freely.
2. Touch two of the cables together – if the motor gets harder to turn you have found a pole pair. If not, try to touch two other cables together until the motor gets harder to move.
3. When you have two cables together that makes it harder to turn the motor, you have found a pole pair.
4. Note the colors for each pole pair (Pair 1 = 1A + 1B, Pair 2 = 2A + 2B)

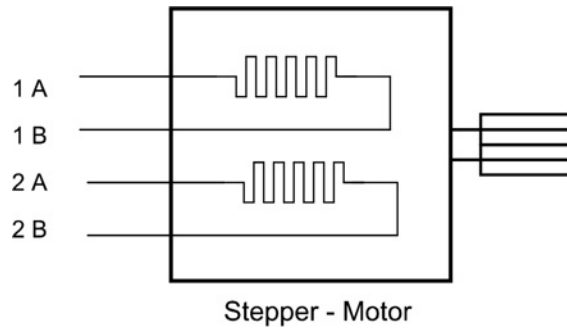

On the Wantai 42BYGHw609 the colors are:

1A = Black

1B = Green

2A = Blue

2B = Red

It does not matter if you swap the pole pairs. If the motor turns the wrong way you can reverse it in the configuration file.



## 2.2 Wiring diagram

### 2.2.1 Silencioso

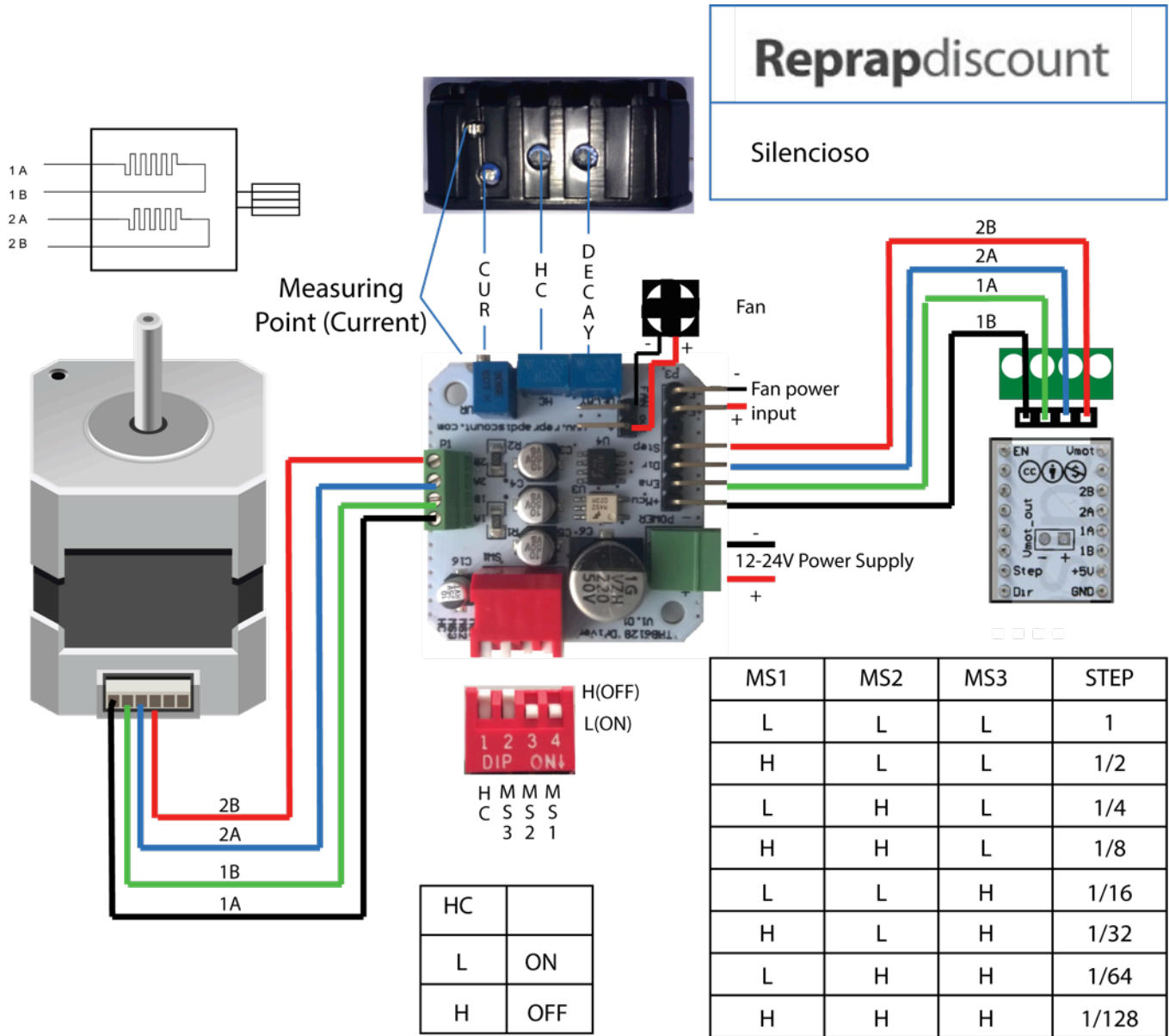

### 2.2.2 Rumba + Silencioso

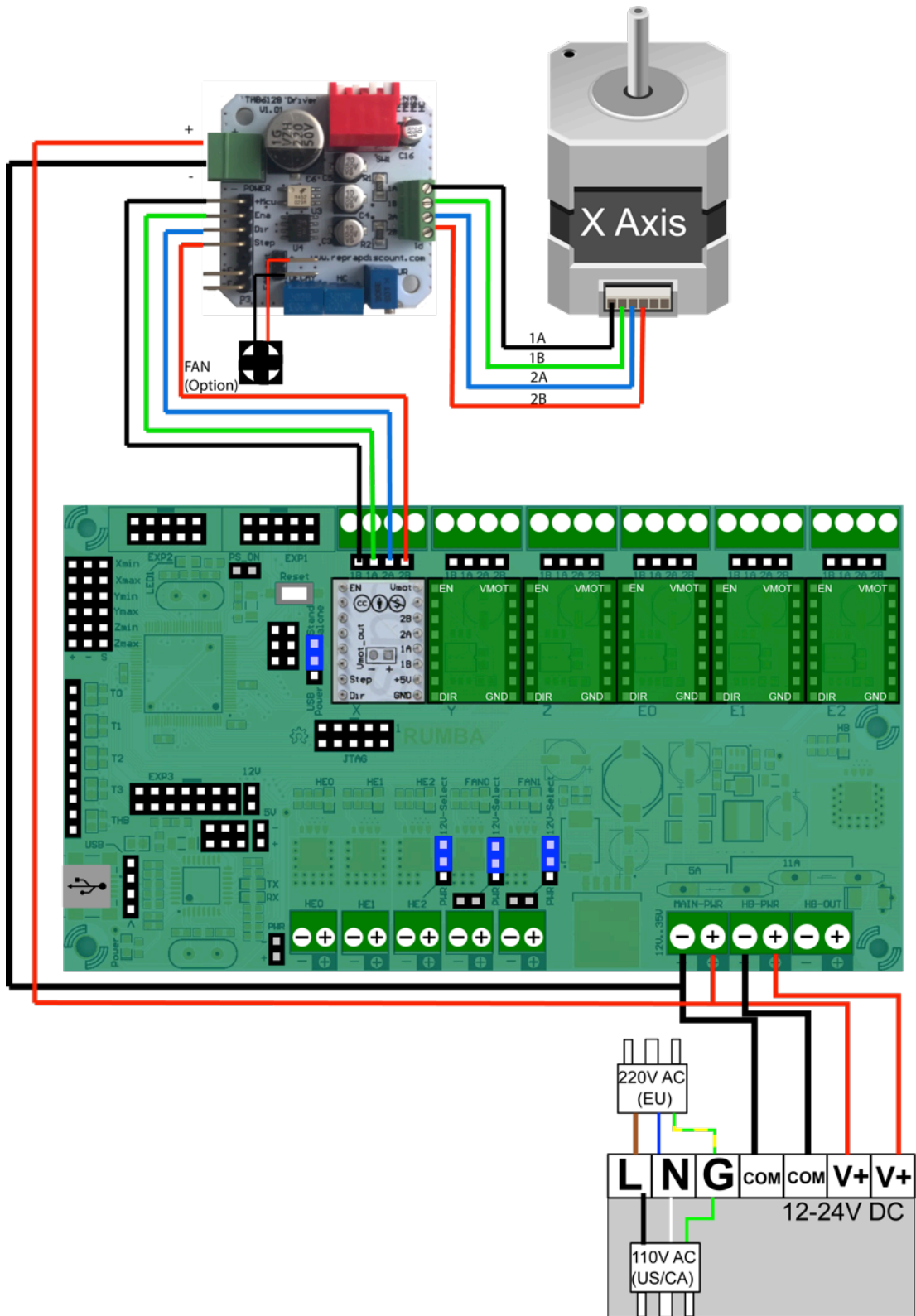

### 2.2.3 Ramps 1.4 + Silencioso

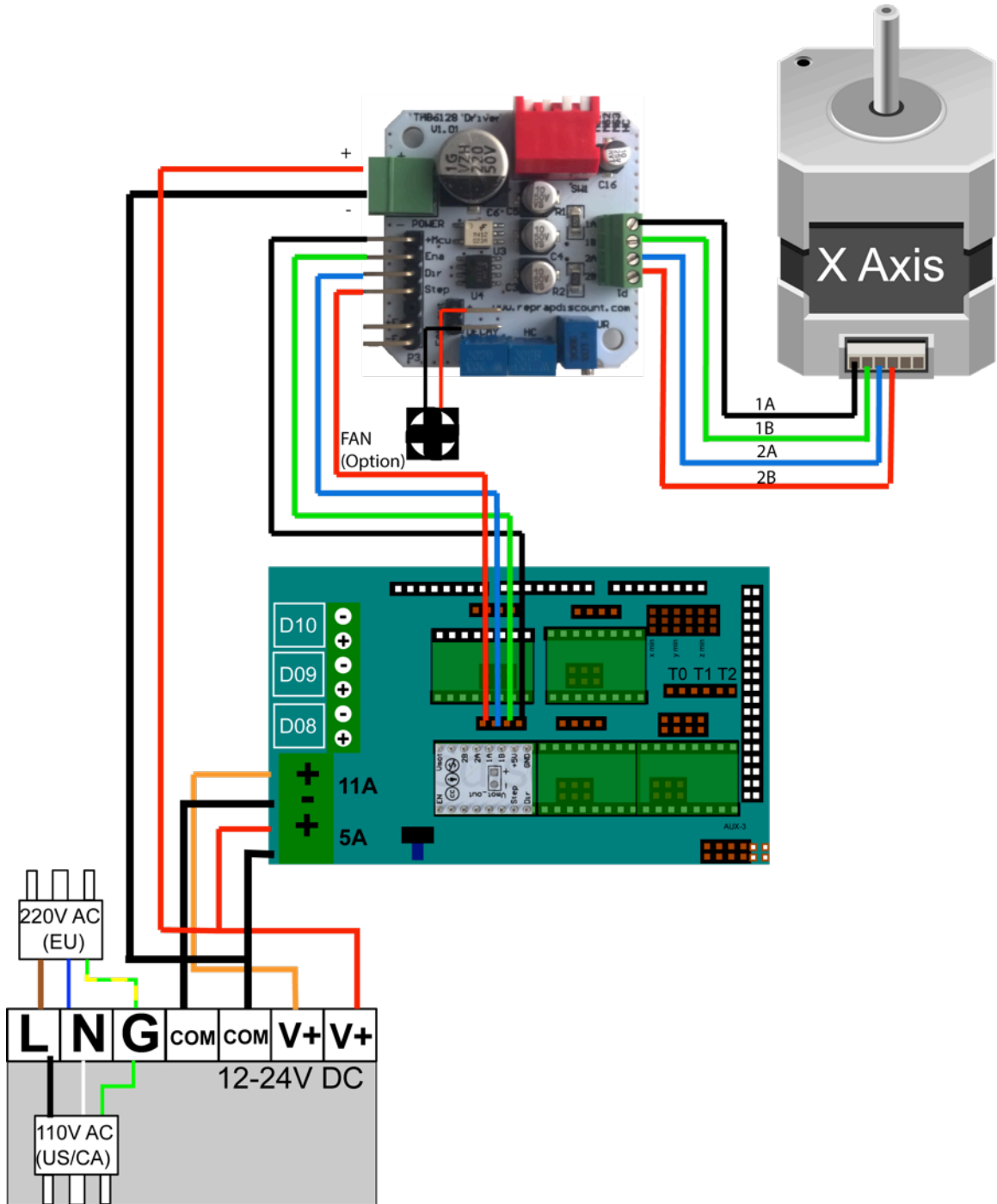

### 2.2.4 Silencioso used in combination with dual motor setup (2 x Z motors). Alternative 1

This is an option if the total current used by the two stepper motors are lower than the Silencioso's max current limit.

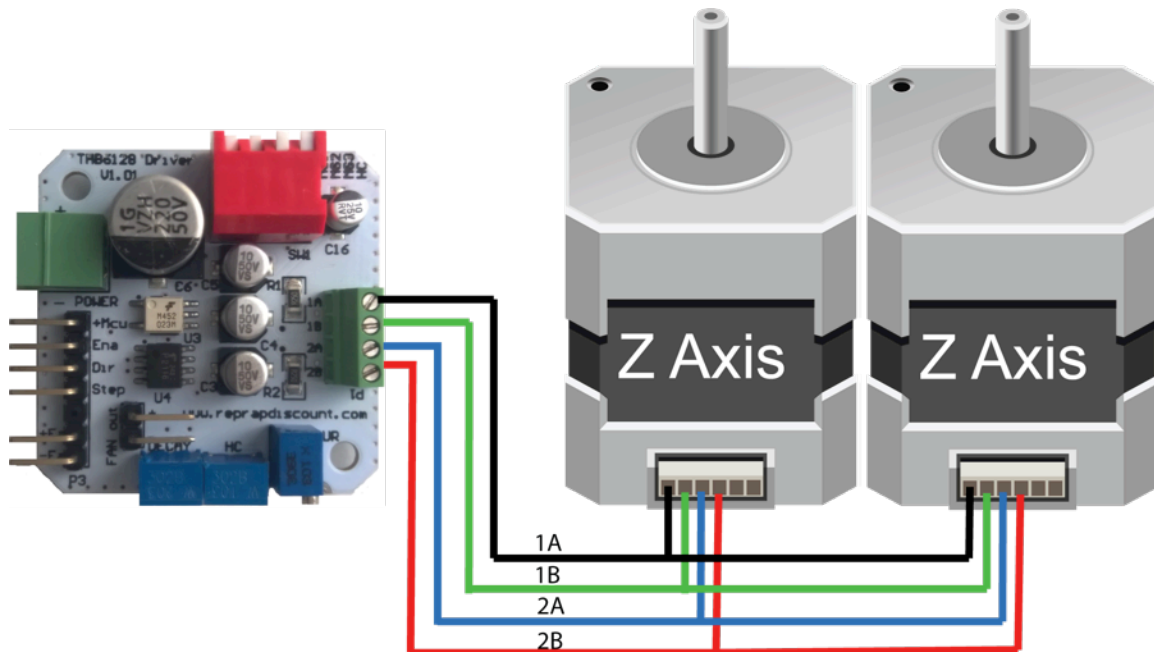





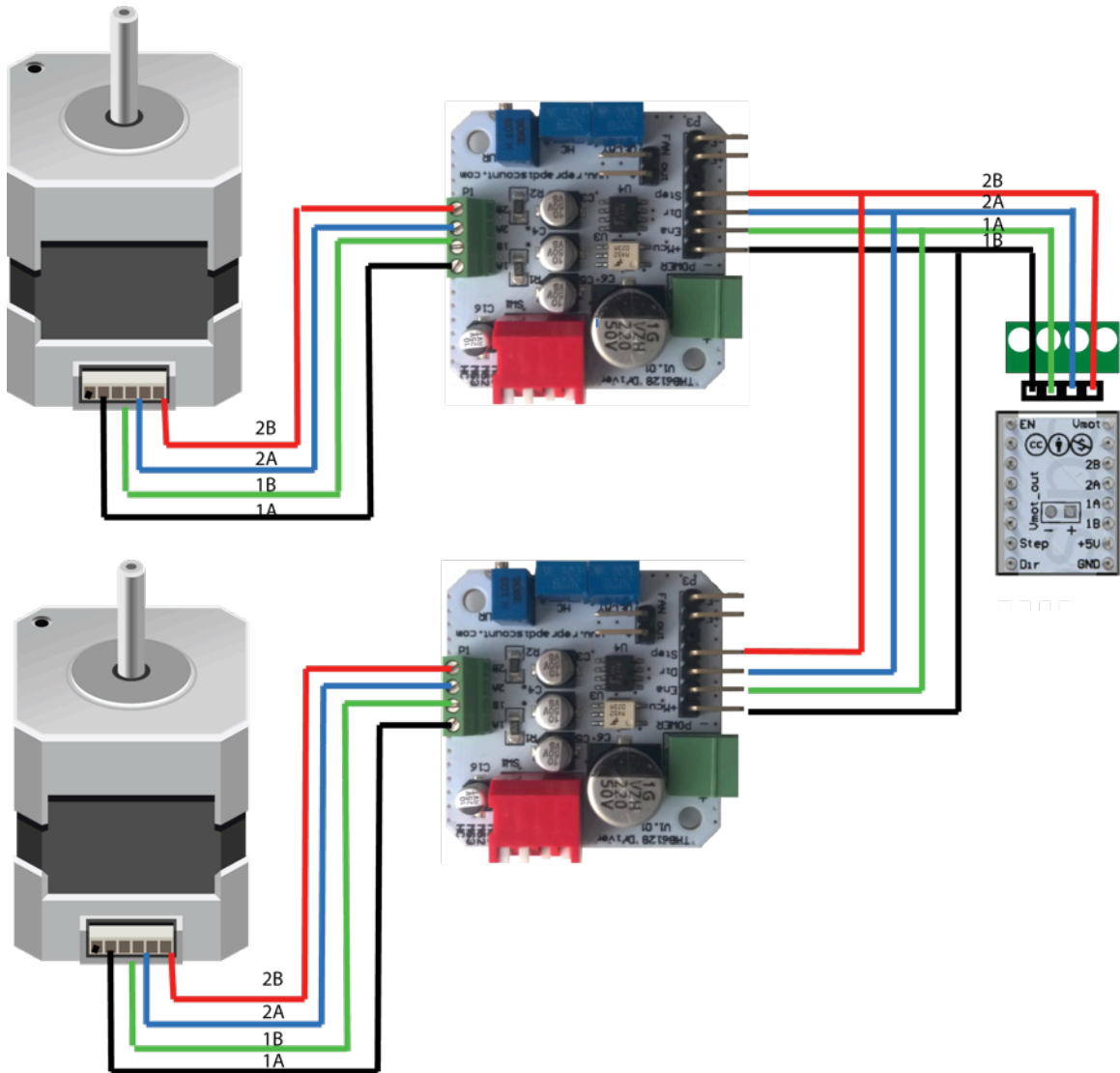



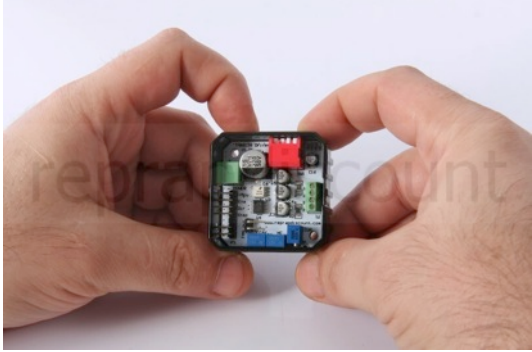

**2.2.5 Silencioso used in combination with dual motor setup (2 x Z motors). Alternative 2**





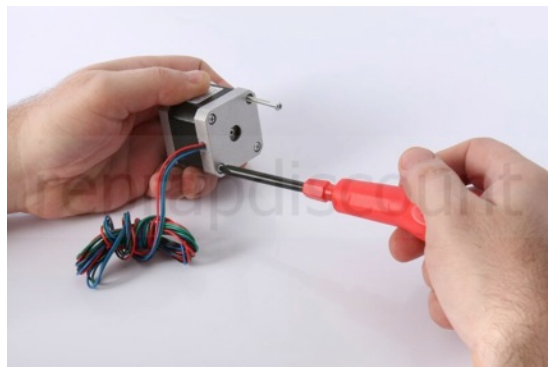

This setup can be used when the total current used by the two motors exceeds the current limit of one Cilencioso



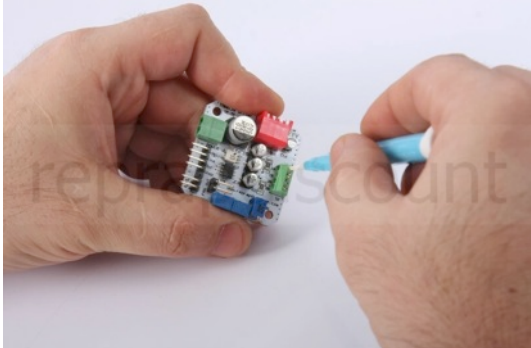

### 2.3 Mounting and Wiring the Silencioso driver on the stepper motor

	
<p>Apply some thermal paste on the chip on the back of the Silencioso board, like in the image</p>	<p>Insert the driver board into the housing with the chip with thermal paste against the housing/cooler.</p>
	
<p>Make sure the driver board is mounted correct in the housing so the contacts on the board correspond with the holes in the housing.</p>	<p>Insert the two screws. Depending on your stepper motor model, you may have to use longer or shorter screws.</p>
	

Mount the two spacers on the screws	Then you are ready to connect the cables
	
Hold the stepper motor like in the image and remove the upper right screw	Then the one in the lower left corner
	
Stepper with the two screws removed	Cut the motor cables (do not cut them shorter than in the image)
	
Strip the insulation from the cables	The motor cables are ready

	
<p>Loosen the screws in the motor connector block</p>	<p>Connect the cables and tighten the screws. Make sure the cables have a good connection.</p>
	
<p>Finished connecting the 4 motor cables</p>	<p>Turn the Silencioso housing so the screws points towards the screw holes in the stepper motor</p>
	
<p>Make sure the cables come out the hole in the side of the housing.</p>	<p>Tighten the two screws</p>



	
<p>Find the motor cable that came with the kit (the cable that goes from the Silencioso to the controller board). Plug the cable into the 4 pins closest to the power connector with the black cable towards the power connector.</p>	<p>Find the power cable that came with the kit and plug it into the power connector – it's not possible to plug this the wrong way. Connect the other end of the power cable to your Power Supply (12-24V)</p>

## 2.4 Mount the stepper adapter on your controller and connect the cables

### 2.4.1 Rumba

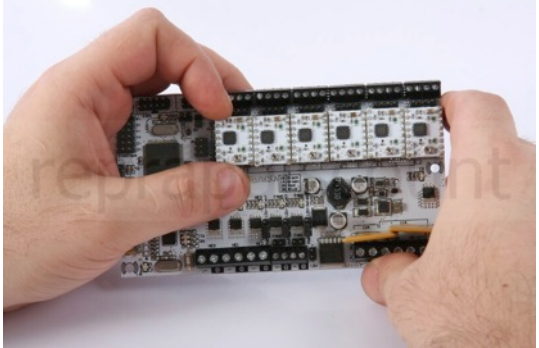
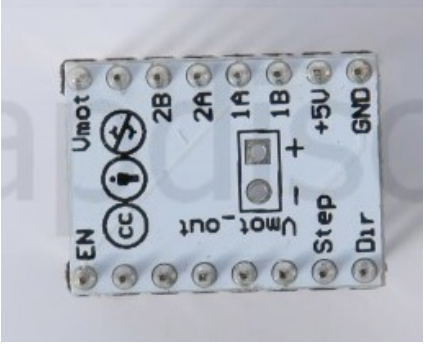
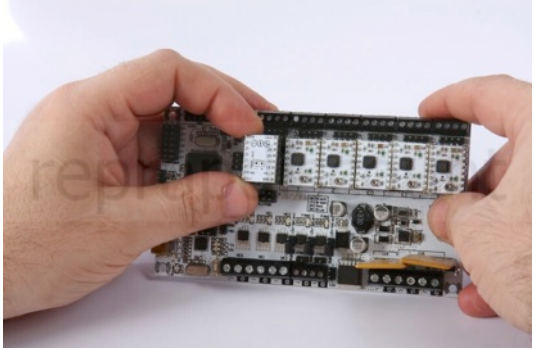
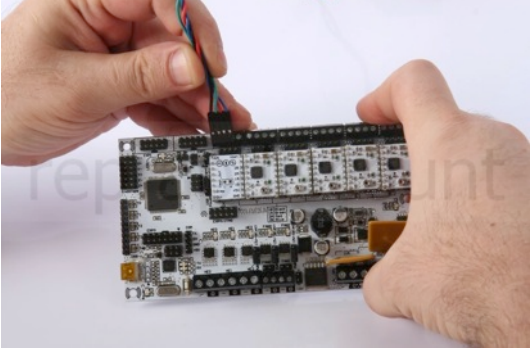
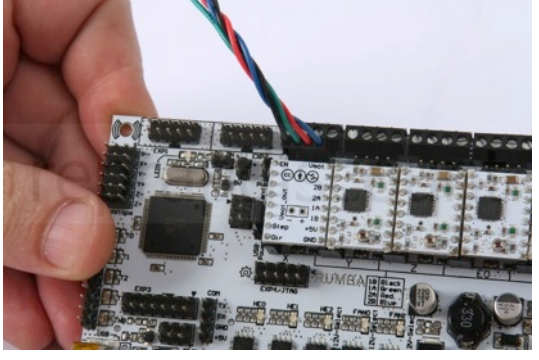
	
<p>If there is a driver in the driver slot, remove it.</p>	<p>Find the driver adapter that came with the kit</p>
	
<p>Insert the adapter with the "EN" pin in the upper left corner</p>	<p>Take the cable that comes from the Silencioso and connect it with Rumba (The black cable at the left side - towards the LCD panel connectors)</p>
	
<p>When you are done, it should look like this.</p>	

2.4.2 Ramps 1.4

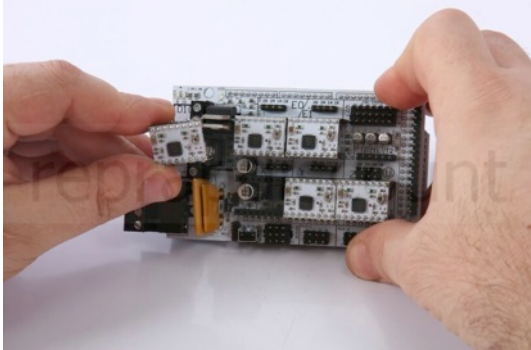
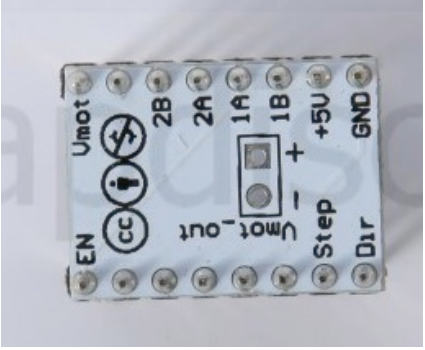
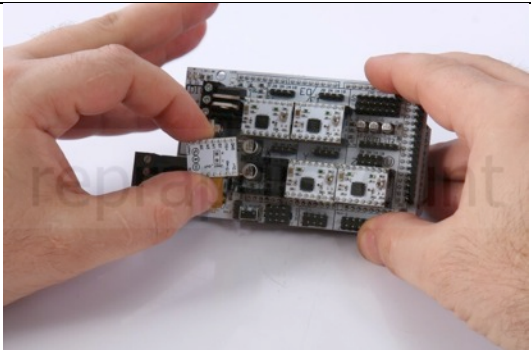
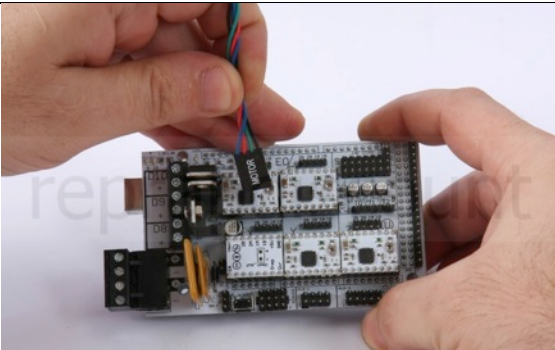
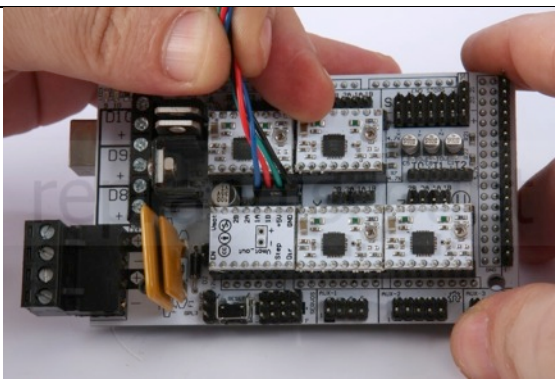
	
<p>If there is a driver in the driver slot, remove it.</p>	<p>Find the driver adapter that came with the kit</p>
	
<p>Insert the adapter with the "EN" pin in the lower left corner</p>	<p>Take the cable that comes from the Silencioso and connect it with Ramps (The black cable at the right side)</p>
	
<p>When you are done, it should look like this.</p>	

## 2.5 Set step mode

Configure the stepping mode by setting the dipswitches on the Silencioso in the correct high/low combination. You find these combinations in the stepping table in the Silencioso wiring diagram.

When you have set the dipswitches, you have to configure the stepping mode in your configuration file to reflect the stepping mode on the Silencioso (chapter 2.10.3).

## 2.6 Adjusting stepper current (CUR)

The stepper current can be set from 0.1A up to 2.1A

## 2.7 Activating and adjusting Hold Current (HC)

Switch the Holding Current (HC) on/off using the HC dipswitch on the Silencioso. When HC is activated (Dipswitch= L) the Holding Current (HC) is set using the HC potentiometer on the Silencioso (linear from 0 to 70% of the stepper current)

## 2.8 Adjusting Decay

Slow current reduction (left)

Fast current reduction (right)

Mix mode (middle)

## 2.9 Connecting a fan

If the Silencioso or stepper motor gets very hot, there is an option to connect one or two fans.

## 2.10 Modify settings in Marlin

Before you can test the Silencioso drivers you may have to alter some settings in the Marlin configuration.h file.

### 2.10.1 Stepper Enable Pins

Drivers like drv8825 and 4988 have inverted enable signal. The Silencioso do not.

If this setting is wrong the motors will not turn.

To correct this you have to edit the configuration.h file and update your controller.

```
// For Inverting Stepper Enable Pins (Active Low) use 0, Non Inverting (Active High)
use 1
#define X_ENABLE_ON 0
#define Y_ENABLE_ON 0
#define Z_ENABLE_ON 0
#define E_ENABLE_ON 0 // For all extruders
```

Settings when using only drv8825 or 4988:

You have to alter the setting from 0 to 1 on the outputs where you have connected a Silencioso driver.

If you have Silencioso drivers on your X and Y-axis the code must be like this:

```
// For Inverting Stepper Enable Pins (Active Low) use 0, Non Inverting (Active High)
use 1
#define X_ENABLE_ON 1
#define Y_ENABLE_ON 1
#define Z_ENABLE_ON 0
#define E_ENABLE_ON 0 // For all extruders
```

### 2.10.2 Stepper rotation direction

If the stepper motor rotates in the wrong direction, you can alter the direction by modifying the configuration.h file

Find the axis you want to alter the value (true or false)

```
#define INVERT_X_DIR true // for Mendel set to false, for Orca set to true

#define INVERT_Y_DIR false // for Mendel set to true, for Orca set to false

#define INVERT_Z_DIR true // for Mendel set to false, for Orca set to true

#define INVERT_E0_DIR false // for direct drive extruder v9 set to true, for
geared extruder set to false

#define INVERT_E1_DIR false // for direct drive extruder v9 set to true, for
geared extruder set to false

#define INVERT_E2_DIR false // for direct drive extruder v9 set to true, for
geared extruder set to false
```

*The settings in Marlin configuration.h file*

### 2.10.3 Steps/mm (micro stepping)

If you want to alter the micro stepping value on one or more axis, you have to set the correct value using the dip switches on the Silencioso and modify the values in the configuration.h file

```
// #define DEFAULT_AXIS_STEPS_PER_UNIT
{78.7402,78.7402,200.0*8/3,760*1.1} // default steps per unit for Ultimaker

//#define DEFAULT_AXIS_STEPS_PER_UNIT {80,80,2560,107} // default steps
per unit for OrdBot 1/16

#define DEFAULT_AXIS_STEPS_PER_UNIT {160,160,5120,214} // default steps
per unit for OrdBot 1/32
```

Each time you increase the stepping one level (sample: from 1/16 to 1/32) you have to multiply the steps per unit value by two.

Sample - You are using 1/16 steps per unit and the value is 80 and want to use 1/32 steps per unit.

If your steps per unit value is 80, you have to multiply 80 by two (2x80).

New steps per unit value = 160

## 3 Appendice/Notes

Some of the wiring diagrams used in this user guide is based on the Rumba and Ramps wiring diagrams in the RepRapWiki.

### 3.1 Recommended pages:

- <http://forum.reprapdiscount.com/>
- [http://reprap.org/wiki/RAMPS\\_1.4](http://reprap.org/wiki/RAMPS_1.4)
- <http://reprap.org/wiki/RUMBA>



